

CAMPINA

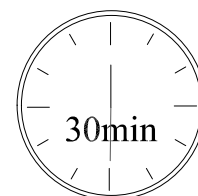

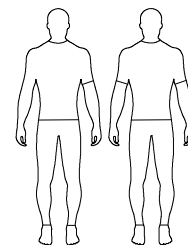

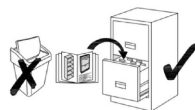
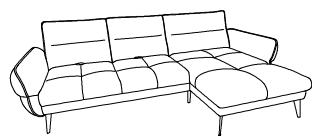
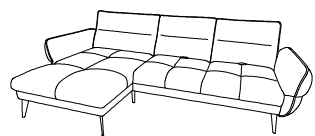
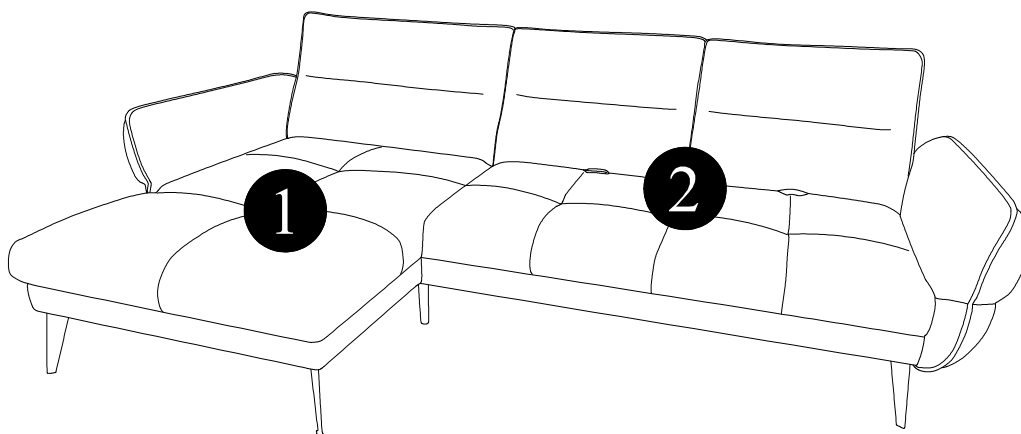

| Teil | L | W | H | Pcs | Colli |
|------|-----|-----|----|-----|-------|
| 1 | 115 | 220 | 86 | 1x | 1/3 |
| 2 | 115 | 172 | 86 | 1x | 2/3 |

L

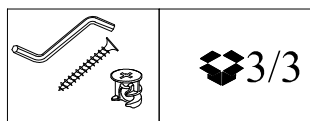
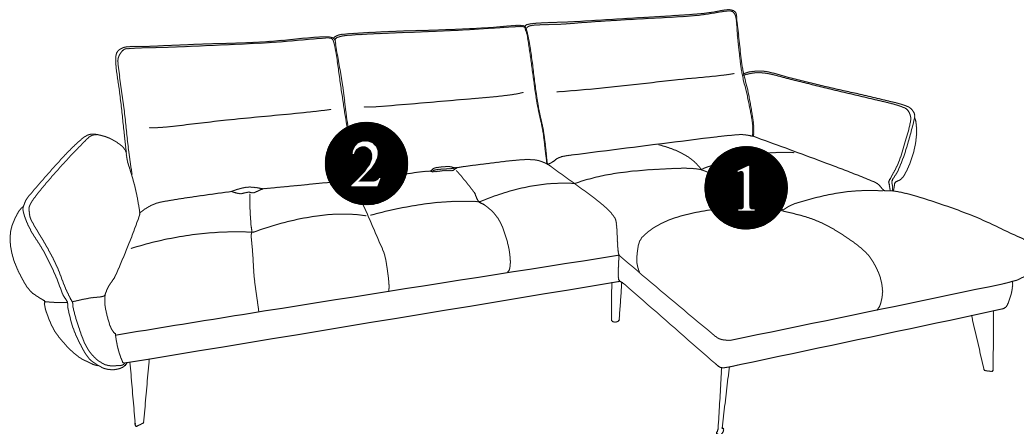

R

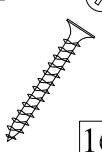

| | | | |
|--|---|---|---|
| A | B | C | D |
|  |  |  |  |
| 4x | 4x | 16x | 4x |
| H-200 | H-200 | 5x40 | ø 20 |

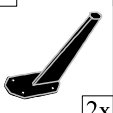
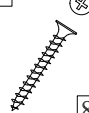



| | |
|--|---|
| A | C |
|  |  |
| 2x | 8x |
| H-200 | 5x40 |

1

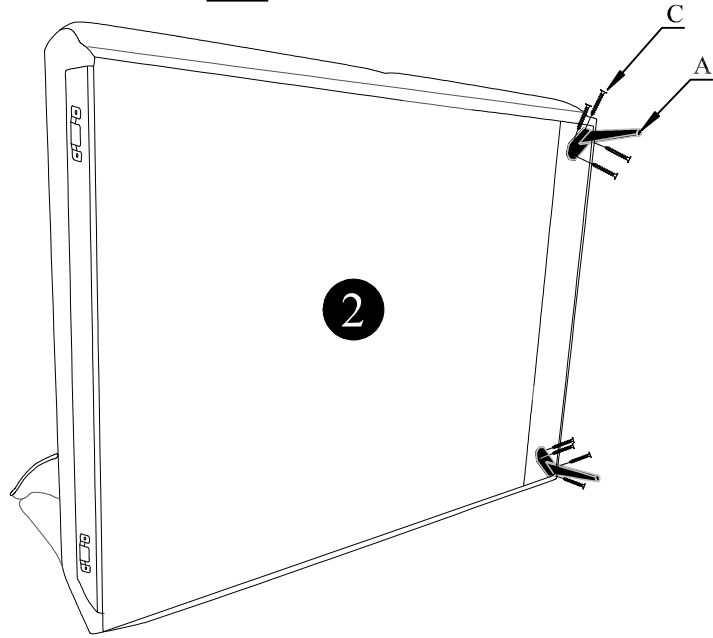
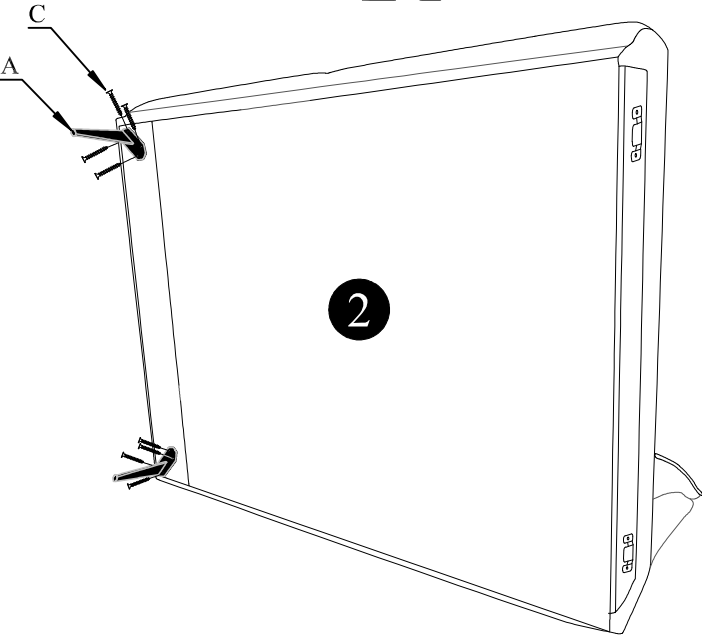
R

L



| | | | |
|--|---|---|---|
| A | B | C | D |
|  |  |  |  |
| 2x | 4x | 8x | 4x |
| H-200 | H-200 | 5x40 | ∅ 20 |

2

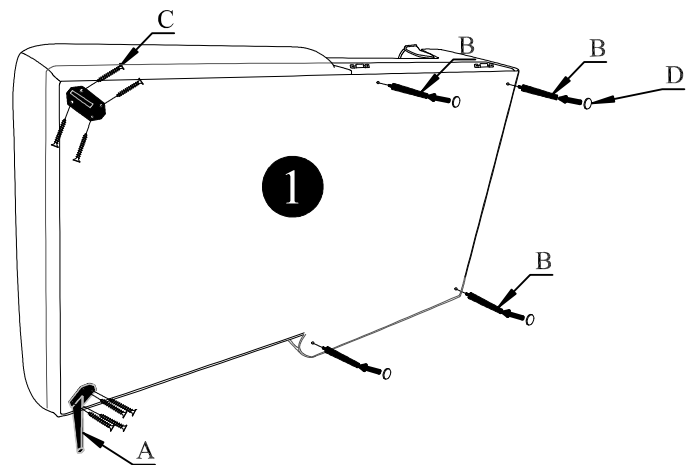
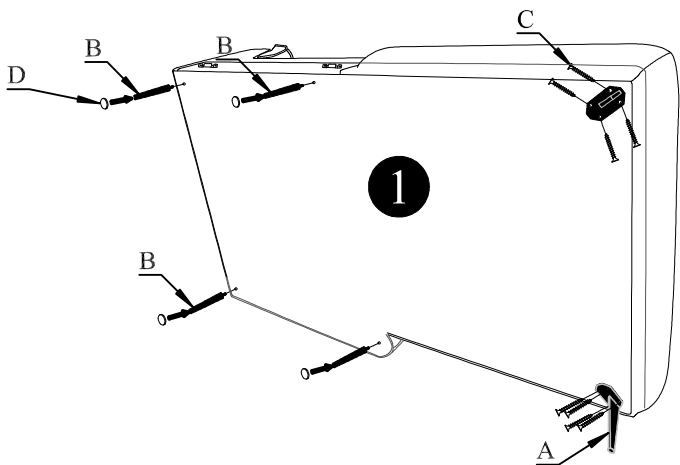

3

